



Summer Math Program
Entering First Grade
Week 6



Fast Facts

See how many you can do in one minute!

7	4	1	4	5	0	4
<u>+ 2</u>	<u>+ 3</u>	<u>+ 8</u>	<u>+ 5</u>	<u>+ 3</u>	<u>+ 2</u>	<u>+ 4</u>

6	2	4	5	4	5	9
<u>- 5</u>	<u>- 2</u>	<u>- 2</u>	<u>- 5</u>	<u>- 0</u>	<u>- 3</u>	<u>- 5</u>





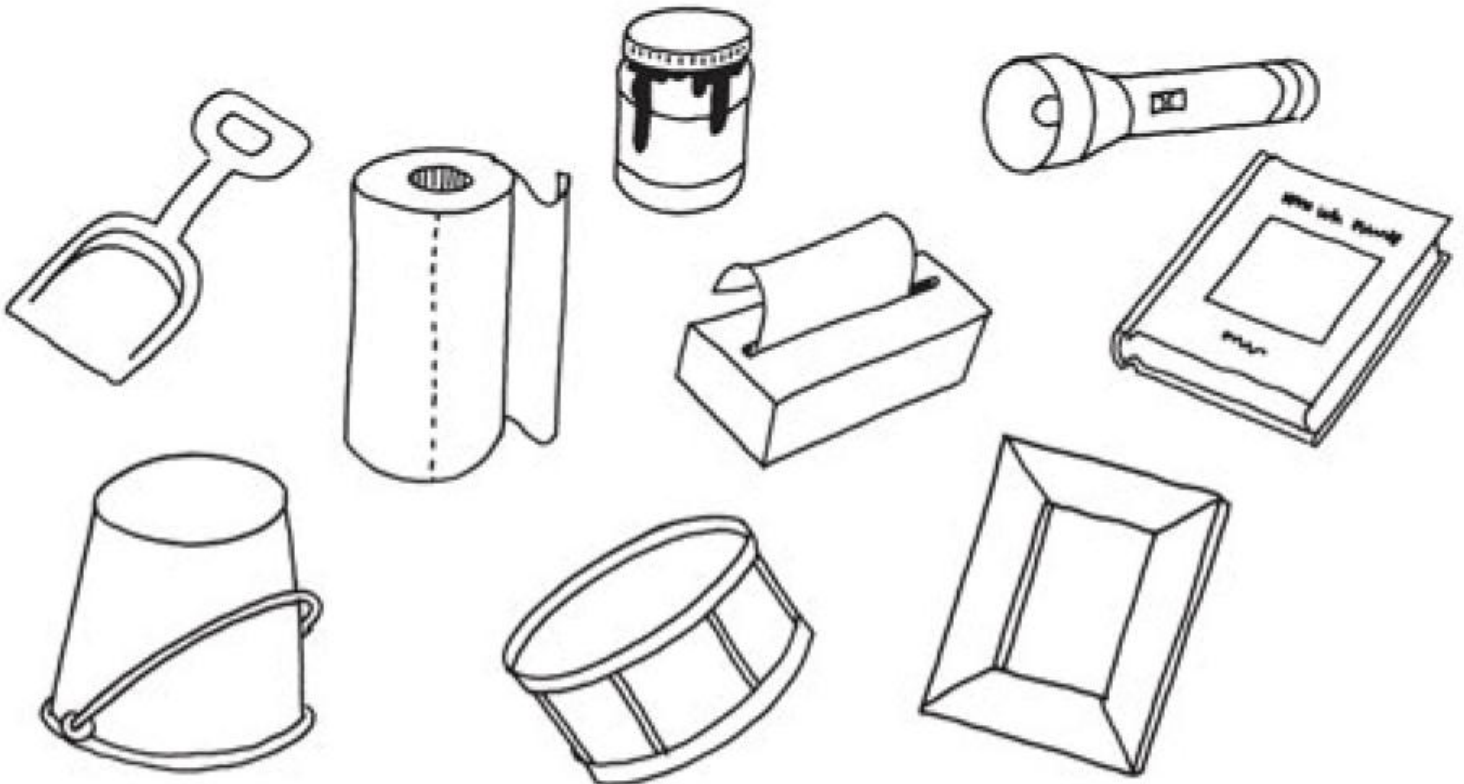

Super Shapes!

Color the objects with a circular surface red. Color the objects with a rectangular surface blue.



Patterns

Circle the shape that comes next in the pattern.

Number Creations

Write down as many ways to get 10 that you can. Use the star counters to help. An example is given.



$$7 + 3 = 10$$

$$\underline{\quad} + \underline{\quad} = 10$$

$$\underline{\quad} + \underline{\quad} = 10$$

$$\underline{\quad} + \underline{\quad} = 10$$

$$\underline{\quad} + \underline{\quad} = 10$$

$$\underline{\quad} + \underline{\quad} = 10$$

$$\underline{\quad} + \underline{\quad} = 10$$

$$\underline{\quad} + \underline{\quad} = 10$$

$$\underline{\quad} + \underline{\quad} = 10$$

$$\underline{\quad} + \underline{\quad} = 10$$

$$\underline{\quad} + \underline{\quad} = 10$$

Web Links

- Pattern Blocks

<http://www.mathplayground.com/patternblocks.html>

- Extra Practice for addition and subtraction facts through 10

http://www.eduplace.com/kids/mw/practice/1/ep1_02.html

Exciting Extras

The following resources are to help your mathematician with fractions and math fluency. Please use the fraction strips (last page) to compare fractions (e.g., $\frac{3}{4}$ is bigger than $\frac{1}{2}$ but smaller than $\frac{5}{6}$), find equivalent fractions (e.g., $\frac{5}{10}$ is equal to $\frac{1}{2}$ which is equal to $\frac{3}{6}$), and for familiarity with how big or little fractions are relative to one whole. The link below takes you to a website for age-appropriate flashcards you can print and use to practice math fluency. Enjoy!!

http://www.helpingwithmath.com/resources/oth_flashcards.htm

Fraction Strips

1 Whole

$\frac{1}{2}$

$\frac{1}{2}$

$\frac{1}{3}$

$\frac{1}{3}$

$\frac{1}{3}$

$\frac{1}{4}$

$\frac{1}{4}$

$\frac{1}{4}$

$\frac{1}{4}$

$\frac{1}{5}$

$\frac{1}{5}$

$\frac{1}{5}$

$\frac{1}{5}$

$\frac{1}{5}$

$\frac{1}{6}$

$\frac{1}{6}$

$\frac{1}{6}$

$\frac{1}{6}$

$\frac{1}{6}$

$\frac{1}{6}$

$\frac{1}{8}$

$\frac{1}{8}$

$\frac{1}{8}$

$\frac{1}{8}$

$\frac{1}{8}$

$\frac{1}{8}$

$\frac{1}{8}$

$\frac{1}{8}$

$\frac{1}{10}$

$\frac{1}{10}$

$\frac{1}{10}$

$\frac{1}{10}$

$\frac{1}{10}$

$\frac{1}{10}$

$\frac{1}{10}$

$\frac{1}{10}$

$\frac{1}{10}$

$\frac{1}{10}$

$\frac{1}{12}$

$\frac{1}{12}$

$\frac{1}{12}$

$\frac{1}{12}$

$\frac{1}{12}$

$\frac{1}{12}$

$\frac{1}{12}$

$\frac{1}{12}$

$\frac{1}{12}$

$\frac{1}{12}$

$\frac{1}{12}$

$\frac{1}{12}$